

PARD



USA
User Manual

Digital Night Vision Front Clip-on
FD1-LRF Series

Scan To Enjoy Privilege



Scan The QR Code to Join Our Membership

- 1 Extend warranty
- 2 Enjoy 1 on 1 expert service
- 3 Get the product experience officer opportunity

CONTENTS

1.INTRODUCTION	02
2.PRECAUTIONS	02
3.PACKAGE CONTENTS	03
4.DESCRPTION & KEY FEATURES	04
5.SPECIFICATIONS	05
6.COMPONENTS	08
7.INSTALLATION	10
8. OPERATION INSTRUCTION	19
8.1 Interface	19
8.2 Shortcut Mode	20
8.3 Functions	25
9. FCC WARNING	34

INTRODUCTION

Thank you for choosing the PARD FD1 night vision front clip-on series. Please read this manual carefully before using the device to ensure proper and safe operation. Please keep this manual in a safe place for future reference. It provides step-by-step instructions for using your night vision scope.











This manual is for reference purposes only and may be subject to updates without prior notice. For the latest information, please visit PARD's official website. PARD reserves the final right to interpret this manual.

PRECAUTIONS

- **Battery Usage:** Please remove the insulating tape from the battery before first use. Use a fully charged lithium-ion battery with a voltage rating of 3.7V.
- **Device Storage:** Turn off the device and remove the battery if not use for more than 10 days. Store the device & battery in a dry and safe place.
- **Handling and Transportation:** Exercise caution when handling or transportation the device. It is recommended to use the original packaging for transportation.
- **Light Exposure:** Do not use the device to focus directly on strong sources of light such as the sun or electric welding. Direct exposure may damage the detector and void the warranty.
- **Lens Protection:** Prevent lens scratches and damage from oil or chemical contamination. Keep the lens cap on when not in use.
- **Environmental Considerations:** Place the device in a cool, dry, and well-ventilated environment. Avoid strong electromagnetic fields. Ensure the storage temperature remains between $-20^{\circ}\text{C}/-4^{\circ}\text{F}$ and $50^{\circ}\text{C}/122^{\circ}\text{F}$.
- **Device Disassembly and Support:** Please refrain from attempting to disassemble the device without proper authorization. Unauthorized disassembly can result in voiding the warranty and may cause irreparable damage to the device. If you encounter any problems, please contact our after-sales team. Report any issues promptly to ensure timely resolution and proper support.

- **Attention! Export Requirements:** Please note that all PARD night-vision and thermal imaging devices require a license for export outside the country.

PACKAGE CONTENTS

Icons	Contents	Quantity
	FD1/FD1-LRF Digital Night Vision Front Clip-on	1
	3.7V 18650 Rechargeable lithium-ion battery	1
	Adapter	1
	Eyepiece	1
	Gasket	4
	Type-C cable	1
	Allen wrench	2
	Cloth bag	1
	User's manual	1
	Warranty card	1

DESCRIPTION & KEY FEATURES

FD1-LRF is a compact, lightweight multifunctional digital night vision clip-on that can be attached to existing your scope. Its low-illumination and high-sensitivity sensor enable hunters to effectively extend their hunting hours well into the night. Furthermore, the device can also be used as a handheld monocular or a mounted scope. Combined a 1200yd LRF module, it enables precise ranging for accurate ballistic calculations and precise hits on targets. With its impressive 6000J impact resistance and IP67 protection rating, it ensures durability and reliable performance. Equipped with a rechargeable 18650 lithium battery, it offers convenience, ease of use, and long-lasting operation.

Key features

- Multipurpose for being a front clip-on, monocular or night vision scope
- No need to be zero (as a clip-on)
- Quick conversion of optical scope to night vision scope
- CMOS Image Sensor
- Ballistic calculator (as Scope)
- 1200yd/1000m LRF
- Visible Light Enhancement Algorithm (VLEA)
- Adjustable beam IR illuminator with a range of 350m
- Recoil-activated recording
- Upgraded UI design
- WiFi
- IP67 weatherproof rating
- 6000J recoil resistance

SPECIFICATIONS

FD1 & FD1-LRF Specification		
Classification	Digital Night Vision Front Clip-on	
Purpose	Scope/Monocular	Clip-on
Sensor		
Type	CMOS	
Resolution(pixel)	1920*1080	
Pixel Size(μm)	2.9	
Frame Rate(Hz)	Color:60/B&W:30	
Image Engine	PARD VLEA	
Optics		
Objective Lens(mm)	30	
Optical Magnification(x)	3.5	1
Digital Zoom(x)	2	N/A
Field of view (HxV)	Horizontal	7.9°
	Vertical	5.9°
	Diagonal	9.9°
Eye Relief(mm)	30	N/A
Diopter Adjustment	- 5D~+5D	N/A

Display		
Type	OLED	
Resolution(pixel)	1440*1080	
Reticle Style	6	
Reticle Color	Red/White/Yellow/Green	N/A
Image Mode	Color /Mono	
Photo / Video		
Photo Resolution(pixel)	2592*1944	
Photo Format	.JPG	
Video Resolution(pixel)	1440*1080	
Video Format	.mp4	
Storage	Micro SD card(128 GB, Max)	
Main function		
LRF Detection Range	1000m/1200yd	
Ballistic Calculator	Yes	N/A
PIP	Yes	N/A
Self-motivated Recording	Yes	
Loop Recording	Yes	
Microphone	Yes	
IR Wavelength(nm)	850/940	
IR Illuminating Level	3 Levels	

Connections	
USB Tpye-C	Yes
WiFi	Yes
Supported Apps	PardVision
Power Supply	
Battery Type	Lithium-ion 18650
Output Voltage(V)	3.7
Operating Time(h)	≤8
External Power Supply	Type-C
Material	
Housing	Aluminum Alloy

COMPONENTS

FD1-LRF

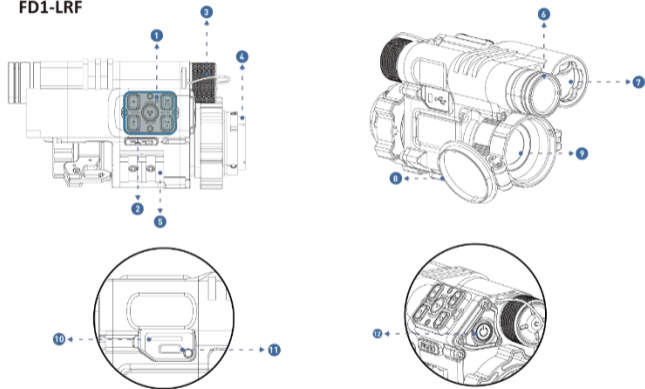

Fig. 1

No.	Name	No.	Name
①	Power indicator	⑦	Ringfinder (LRF)
②	Keypad	⑧	Objective lens cap
③	Battery compartment cap	⑨	Objective lens
④	Clip-on eyepiece	⑩	Micro SD card slot
⑤	Picatinny rail	⑪	Type-C charging port
⑥	Adjustable beam IR illuminator	⑫	Power/Sleep button

INSTALLATION

1. Unboxing

Before using this device, please follow these steps:

- 1 Open the box and carefully remove the device.
- 2 Verify that all items listed in the package contents are included in the box.
- 3 Inspect the device for any signs of damage to the display, body, lens, buttons, and other components.
- 4 Ensure that the objective lens and eyepiece are clean and in proper working condition.

Note: If you find any accessories missing or damaged, please contact our after-sales service for assistance.

2. Battery Installation and Startup

Please following the steps below for battery installation:

- (1) Turn the battery cap counterclockwise to open it and remove the battery.
- (2) Remove the insulating tape from the battery.

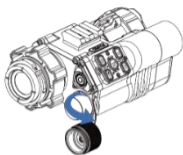

Fig. 2

- (3) Insert the battery with the positive pole (+) facing inward, then rotate the battery cap clockwise until it is tightly locked in place.

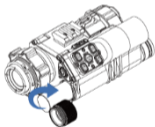

Fig. 4



Fig. 3

- (4) To power on the device, press and hold the power button for approximately 3 seconds. The device is ready for use when the power indicator illuminates and the PARD Logo appears on the screen.

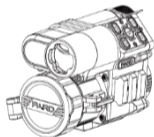

Fig. 5

Note:

- ① Use a single 18650 rechargeable lithium-ion battery with a voltage rating 3.7V;
- ② Do not expose the battery pack to high temperature or to a naked flame.
- ③ Do not put the device into water when the battery cover is open;

- 4 Do not expose or disassemble the device without authorization;
- 5 Do not pierce the device with sharp objects;
- 6 Battery should be kept out of reach of children, and the positive and negative terminals of the battery should be installed correctly;
- 7 Whilst charging the battery do not leave the battery unattended.
- 8 When using the battery at cold (low) temperatures, the battery capacity decreases, this is normal and not a defect.
- 9 Do not use the battery if it has been damaged in any way.
- 10 After charging is complete do not leave the battery on charge connected to the network.



Please act responsibly and recycle or dispose of all used batteries according to the law.

3. Adapter Installation

To ensure optimal performance and user experience, we highly recommend using our original adapter provided in the product packaging as shown in Fig. 6.

The adapter installation steps are as follows:

- 1 Remove the digital night vision device, adapter, gaskets and Allen wrench from the box.
- 2 Apply 1-2 layers of insulating tape to protect the scope's objective lens.
- 3 Attach and rotate the clip-on eyepiece onto the digital night vision body.
- 4 Align the clip-on eyepiece with the adapter's inner recess, then secure it to the night vision device using the pin with knurled thumbnut.
- 5 Choose the right gasket(s) for your scope's objective bell diameter. Attach the assembled device to the scope's objective bell, ensuring the display is centered through your scope's eyepiece. Secure by lowering and tightening the

adapter locking lever.

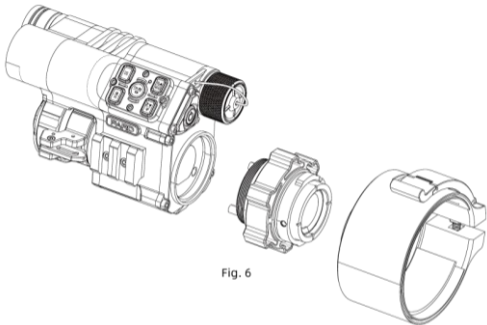

Fig. 6

4. Focusing

Diopter Adjustment Ring

Diopter adjustment in a night vision device refers to the ability to adjust the focus of the device's eyepiece to compensate for differences in users' vision. It allows individuals with varying levels of eyesight to achieve a clear and focused view of the displayed content on the device's screen.

- 1 After turning on the device, rotate the diopter adjustment ring until the texts or icons on the screen are clearly.
- 2 Please note that the image may not be clear after diopter adjustment. As long as the text on the screen is clear and

visible, it is sufficient.

Note: If the objective lens is not properly focused, the image may be unclear.

Objective Lens Adjustment Ring

- 1 Before adjusting the objective lens, it is important to complete the diopter focusing.
- 2 Then adjust the objective lens focus ring until a clear image of the target is achieved.

5. E-compass Calibration

Once the eyepiece is properly focused, proceed to calibrate the electronic compass using the "Figure 8" pattern method. Tilt and move the device in a Figure 8 motion until the compass is calibrated, as indicated in **Fig. 7**.



Fig. 7

6. Zeroing

Reticle adjustment refers to aligning the reticle with the point of impact at a specific zeroing distance. This ensures that the aiming point coincides with the actual point of impact at that distance.

Interface Explanation

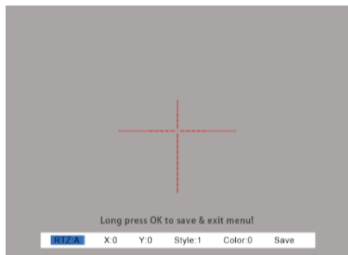
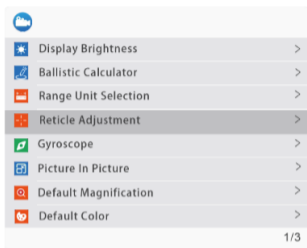

Fig. 8

- The first item “RTZ” allows you to save the current setting profile. You can save up to five sets of data (A-E);
- The second item “X” represents the X axis of the cross line.
- The third item “Y” represents the Y axis of the cross line.
- Style corresponds to the crosshair type (7 options available).
- Color corresponds to the color of the cross line (red/white/yellow/green).
- Under the Save option, “Y” indicates to save the changes, and “N” indicates not to save them.

Zeroing Steps

Note: Ensure proper installation before zeroing the FD1/FD1-LRF. Please follow these steps to zero your device:

- 1 **Set the target:** Set the target at zeroing distance and ensure that the device provides a clear image of the target.
- 2 **Enter the reticle adjustment (Zeroing page):** From the home screen, press [Key 5] to access the menu. Then press [Key 2] to select the reticle adjustment option as shown in **Fig. 9**. Press [Key 3] to enter the sub-menu interface.

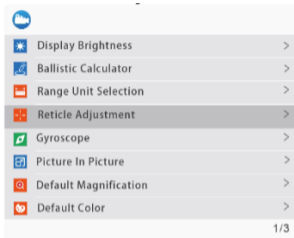

Fig. 9

- 3 **Profile setting:** Once on the zeroing page, press [Key 2] or [Key 4] in RTZ item to create a new zeroing profile or edit an existing one (**Fig. 10**).

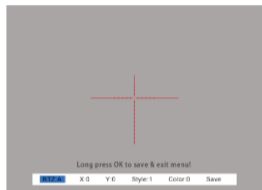

Fig. 10

④ **Shoot:** Fire a shot at the center of the target (A) and ensure that the point of impact(B) is clearly visible on the screen as shown in **Fig. 11**.

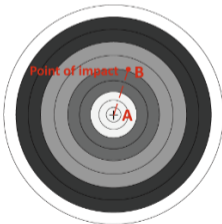

Fig. 11

- ⑤ **Adjust zero value:** press [Key 3] to move the cursor to the "X" item, click [Key 2] or [key 4] to freeze the screen. Press [Key 2] or [Key 4] again to adjust the value of "X". Similarly, move the cursor to the "Y" item by pressing [Key 3], and adjust the value of "Y" with [Key 2] or [Key 4] until the center point of the reticle (A) aligns with the point of impact (B) on the display screen;
- ⑥ **Save and exit:** Press [Key 3] to the "Save" item, use [Key 4]/ [Key 2] to choose "Save:Y"/"Save:N", then press [Key3] to confirm. Alternatively, press and hold [Key 3] to save and exit. The center point of the reticle(A) will now align with the point of impact(B).

OPERATION INSTRUCTION

Interface

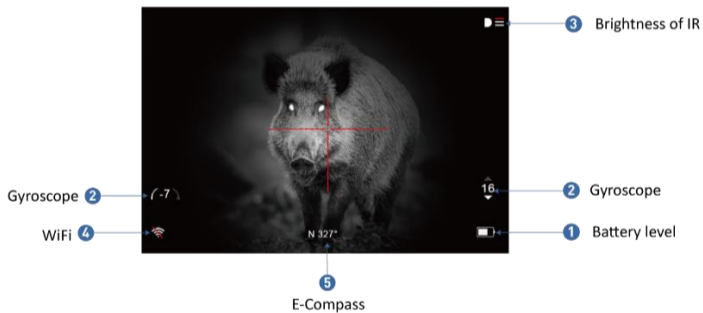

Fig. 12

Shortcut Mode

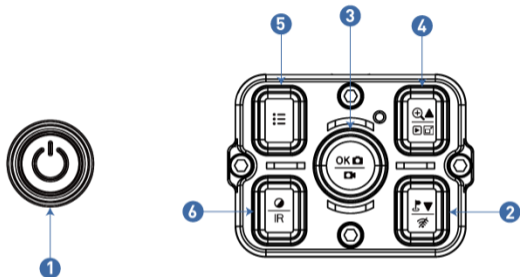

Fig. 13

Keypad	Single press	Press and hold	Double press
①	Power/Sleep button	Power on/off	-
②	IRF on/ Ballistic Calculator/Down key	Disable WiFi	-

3	OK/Take photo	Record Video/Save	-
4	Up key/Zoom in	Browse files	Open/Close PIP
5	Menu/Play back	Play back	
6	Brightness of IR (Black&White mode)	Switch between black&white/color mode	

Note: All operations of the FD1 are the same as the FD1-LRF, with the only difference being that the FD1-LRF is equipped with a built-in rangefinder module.

Explanation:

Key 1(Power key):

1. Single press:

Click it to enter sleep mode, and click again to exit sleep mode;

2. Press and hold:

Press and hold the power button for 3 seconds to power on/off the device;

Key 2:

1. Single press:

- ① When the ballistic calculation function is turned off, press [key 2] to turn on the LRF function (For the LRF version, the distance will be measured and displayed automatically). For the non-LRF version, the distance will not be measured automatically and will display "[0]m or [0]yds". You can manually input the target distance value by pressing [Key 2] or [Key 4]. Press [key 2] to deactivate the range indicator.

When the ballistic calculation function is enabled, press [key 2] to active the LRF function (For the LRF version, the distance will be measured and displayed automatically). For the non-LRF version, the distance will not be measured automatically and will display "[0]m" or "[0]yds". You can manually input the target distance value by pressing [Key 2] or [Key 4]. Press [key 2] again to enable the ballistic calculation function and indicate the impact point. Press [key 2] to exit the ballistic calculation function interface.

- ② **Menu mode:** single press it to increases value or navigate forward through options;

2. Press and hold:

press and hold [Key 2] to toggle WiFi on/off.

Key 3:

1. Single press:

- ① **Home screen mode:** press [Key 3] to take photo;
- ② **In the menu mode:** press [Key 3] to confirm your selection.

2. Press and hold:

Home screen mode: press and hold [Key 3] to start video recording (with Micro SD card inserted), and long press [key 3] again to save the video and exit.

Key 4:

1. Single press:

In Black&White mode, with the IR illuminator turned on, press [Key 3] to adjust the brightness level of the IR illuminator. Each press will cycle through the following options: Off - 1 Level - 2 Level - 3 Level - Off.

2. Press and hold:

- ① When the WiFi function is turned off, press and hold [key 4] to access the video files interface;
 - a) In the video files interface, press [Key 2] or [Key 4] to switch the video file;
 - b) Press [Key 3] to play or pause the video;
 - c) While playing the video, pressing [Key 2] or [Key 4] will allow you to fast forward or rewind at 2x, 4x, or 8x speed;
 - d) Press [Key 5] to return to the video file interface, and then press [Key 5] again to access the following settings;

1)Delete: <ul style="list-style-type: none">● Delete Current● Delete All	2)Protect: <ul style="list-style-type: none">● Lock Current● Unlock Current● Lock All● Unlock All	3)Slide Show: <ul style="list-style-type: none">● 2 seconds● 5 seconds● 8 seconds
---	--	---

Note: press [Key 2]/[Key 4] to toggle through these settings and use [Key 3] to confirm your selection:

- e) Press [Key 5] to exit the above settings and return to the video file interface;
- f) Then, press and hold [Key 5] to exit the video files interface and return to the home screen.

3. Double press:

Home screen mode: double press [Key 4] to toggle the PIP function on/off.

Key 5:

1. Single press:

- ① **Home screen mode:** press [Key 5] to open the menu, press [Key 5] again to close the menu.
- ② **menu mode:** press [Key 5] to return to home screen mode.

2. Press and hold:

Home screen mode: press and hold [Key 5] to return to home screen mode.

Key 6:

1. Single press:

In Black&White mode, with the IR illuminator turned on, press [Key 6] to adjust the brightness level of the IR illuminator. Each press will cycle through the following options: Off - 1 Level - 2 Level - 3 Level - Off.

2. Press and hold:

Home screen mode: press and hold [Key 6] to toggle between Black&White and Color mode.

Functions

Home screen mode: press [key 5] to enter the menu mode, where you can set various function options within the menu bar. Please note that the shortcut key function is disabled in this mode (**Fig. 14**).

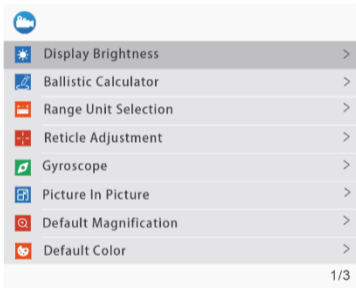

Fig. 14

1. Display Brightness

This function allows you to adjust the brightness of the screen.

- Press [Key 2] to display brightness option. Press [Key 3] to enter the sub-menu interface.
- Select "0", "Level 1", "Level 2", "Level 3", "Level 4", "Level 5", or "Level 6" by pressing [Key 2]/[Key 4].

2. Ballistic calculator

The ballistic calculator is designed to calculate bullet trajectories and provide precise aiming points, ensuring accurate shot placement. With support for up to five profiles, users can utilize the scope across multiple hunting tools.

- Home screen mode: press [Key 2] to access the ballistic calculator option. Press [Key 3] to enter the sub-menu interface.
- Use [key 2] or [Key 4] to navigate and select either "Parameters" or "On/Off" and then press [Key 2] to save your selection or enter the Parameters option.
- Adjusting Ballistic Calculator Parameters: once inside the ballistic calculator parameters sub-menu, press [Key 3] to scroll up or down and locate the desired parameter. press [Key 2] or [Key 4] to adjust the value of the corresponding parameter.

Note: For the parameter settings, please refer to the official website.

3. Range Unit Selection

Users can easily switch between "meter" or "yard" as the range to meet their preference.

- Press [Key 2]/[Key 4] to access the range unit selection option. Press [Key 3] to enter the sub-menu interface.
- Use [Key 2]/[Key 4] to select the desired option, either "meter" or "yard". Press [Key 3] to confirm the selection and return to the previous page.

4. Reticle Adjustment

Reticle adjustment refers to aligning the reticle with the point of impact at a specific zeroing distance. This ensures that the aiming point of the scope coincides with the point of impact at that particular distance.

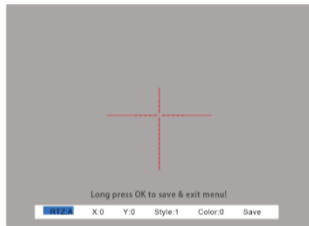

Fig. 15

- Press [Key 2]/[Key 4] to the reticle adjustment option. Press [Key 3] to enter the sub-menu interface (**Fig. 15**).
- Once inside the reticle adjustment sub-menu, press [Key 3]/[Key 5] to switch between sub-options and use [Key 2] or [Key 4] to adjust the value of the corresponding parameter (for detailed instructions, please refer to the zeroing explanation in the installation steps);
- After selecting your preferred settings, you have two options to save them: 1. Select “Yes” under the Save option and press [Key 3] to save and exit; 2. Regardless of whether “Yes” or “No” is selected under the Save option, you can also press and hold [Key 3] to save and exit.
- Set “No” under the Save option and press [Key 3] to exit without saving.

5. Gyroscope

This function allows for sensing the position status of the device, displaying and calibrating its yaw and pitch angles.

- Press [Key 2]/[Key 4] to move the cursor to the gyroscope option, and press [Key 3] to enter the sub-menu.
- Press [Key 2]/[Key 4] to select "Display" or "Calibration", and then press [Key 3] to enter the selected option.
- In the "Display" option, choose whether to display the yaw and pitch angle on the home screen. Press [Key 2]/[Key 4] to select "Off" or "On" and press [Key 3] to save and return to the menu.
- "Calibration" represents entering the calibration state. Please place the device on a horizontal plane surface, and press [Key 3] to perform automatic calibration. After calibration, the device will automatically return to the home screen.

6. Picture In Picture (PIP)

The top center of the display can show a 2x magnified picture for enhanced aiming visibility. This allows you to see magnified target details without sacrificing the field of view.

7. Default Magnification

This function allows you to select the default magnification level of the night vision spectrum channel when the device is powered on.

- Press [Key 2]/[Key 4] to the default magnification option. Press [Key 3] to enter the sub-menu interface.
- Select the desired default magnification, click [Key 3] to save and return to the menu.

8. Default Color

This function allows you to select the default color mode for the night vision spectrum of this device. There are two options available: color and black&white mode.

- Press [Key 2]/[Key 4] to the default color option. Press [Key 3] to enter the sub-menu interface.
- Select the desired default color, click [Key 3] to save and return to the menu.

9. Brightness of IR

This function allows you to adjust the brightness of IR illuminator.

- Press [Key 2]/[Key 4] to the brightness of IR option. Press [Key 3] to enter the sub-menu interface;
- Press [Key 2]/[Key 4] to select among "Off", "1", "2", "3" option and then press [Key 3] to save and return to the previous page.

10. Recoil-activated recording

When the device detects recoil, the entire shooting process will be recorded in 20-second intervals. Each 20-second segment of the shooting event will be saved on the TF card.

- Press [Key 2]/[Key 4] to the recoil-activated option. Press [Key 3] to enter the sub-menu;
- Press [Key 2]/[Key 4] to select from "OFF", "ON" and "Impact Sensitivity" options;
- Once selecting from "Off" or "On", press [Key 3] to save and return to the previous page.
- After selecting "Impact Sensitivity", press [Key 3] to enter the sub-option of sensitivity level. Press [Key 2]/[Key 4] to select "Off", "Low", "Medium" or "High" mode. Press [Key 3] to save and return to the previous page.

11. Auto Power Off

When this function is enabled, the device will detect the last button operation as the starting point and execute the auto power-off command based on the set shutdown duration. This setting will be retained and continue after the next power-on.

- Press [Key 2]/[Key 4] to move the cursor to select the auto power off setting, and press [Key 1] to enter the sub-menu.
- Press [Key 2]/[Key 4] to select "Off", "1 Min", "2 Min", "3Min", "5 Min", "10 Min" or "30 Min" duration options. After selection, press [Key 3] to confirm and save, and return to the previous page.

12. Auto Recording

Once this function is enabled, the device will initiate automatic recording and continue this operation after the next power-on.

- Press [Key 2]/[Key 4] to the auto recording option. Press [Key 3] to enter the sub-menu.
- Press [Key 2]/[Key 4] to select "Off" or "On" options, and then press [Key 3] to save and return to the previous page.

13. Loop Recording

Users can customize the segment recording duration by accessing the loop recording settings. When the memory card reaches its full capacity, new recordings will automatically overwrite the previously saved files. Selecting "Off" will stop recording when the memory card is full, and the oldest video file will not be overwritten.

- Press [Key 2]/[Key 4] to the loop recording option. Press [Key 3] to enter the sub-menu.
- Press [Key 2]/[Key 4] to select "Off", "1 Min", "3 Min", "5 Min" or "10 Min" and then press [Key 3] to save and return to the previous page.

14. Date Stamp

Users can customize the display of a time stamp in the lower right corner of captured photos and videos.

- Press [Key 2]/[Key 4] to the date stamp option. Press [Key 3] to enter the sub-menu;
- Press [Key 2]/[Key 4] to select "Off" or "On" options, and then press [Key 3] to save and return to the previous page.

15. Record Audio

User can choose whether to record audio along with the video.

- Press [Key 2]/[Key 4] to the record audio option. Press [Key 3] to enter the sub-menu;
- Press [Key 2]/[Key 4] to select "Off" or "On" options, and then press [Key 3] to save and return to the previous page.

16. WiFi

Through the WiFi connection, you can use your phone, PC or tablet as an external viewfinder enabling users to synchronously see the photos and videos on a larger screen.

- Press [Key 2]/[Key 4] to the WiFi option. Press [Key 3] to enter the sub-menu;
- Press [Key 2]/[Key 4] to select "Off" or "On" options. Choose "Off" and press [Key 3] to save and go back to the previous page. Select "On" to enable Wi-Fi and return to the home screen.

Steps to connect to your mobile device:

- Download "PardVision" from the Apple App Store or the Google Play Store.
- Enable Wi-Fi on both your device and your mobile device.
- Search for the Wi-Fi network on your mobile device (the device Wi-Fi network is a string of characters starting with PARD, which is a unique string of numbers). Please enter the password: 12345678 to connect.

- Enter the application to operate and use.

Note: After enabling Wi-Fi, you cannot access the menu. Press and hold [Key 4] to disable the Wi-Fi and then enter the menu interface.

17. Exposure

Users can choose their preferred exposure settings.

- Press [Key 2]/[Key 4] to the exposure option. Press [Key 3] to enter the sub-menu;
- Use [Key 2]/[Key 4] to select your preferred option, and then press [Key 3] to save and return to the previous page.

18. Language

Users can choose their preferred language.

- Press [Key 2]/[Key 4] to the language option. Press [Key 3] to enter the sub-menu;
- Press [Key 2]/[Key 4] to your preferred language and then press [Key 3] to save and return to the previous page.

19. Date/Time

Users can set the system date and time of the device.

- Press [Key 2]/[Key 4] to the date/time option. Press [Key 3] to enter the sub-menu;
- Press [Key 2]/[Key 4] to adjust the date and time value, and then press [Key 3] to switch options. Press [Key 5] to return to the previous page.

20. Format

Please note that reformatting the TF Card will permanently delete all data, and it cannot be recovered. Please operate with caution!

- Press [Key 2]/[Key 4] to the format option. Press [Key 3] to enter the sub-menu;
- Press [Key 2]/[Key 4] to select "Cancel" or "OK" option. After selection, press [Key 3] to confirm the relevant operation and return to the previous page.

21. Default Setting

Resetting the device will restore it to the factory default settings, deleting all user data and personalized settings. Proceed with caution when performing this operation!

- Press [Key 2]/[Key 4] to the default setting option. Press [Key 3] to enter the sub-menu;
- Press [Key 2]/[Key 4] to select "Cancel" or "OK" option. After selection, press [Key 3] to confirm the relevant operation and return to the previous page.

22. Version

This function displays the device's version.

- Press [Key 2]/[Key 4] to the version option. Press [Key 3] to enter the sub-menu;
- Press [Key 3] again to return to the previous page.

FCC WARNING



This device complies with part 15 of the FCC Rules. Operation is subject to the following two conditions:

- (1) This device may not cause harmful interference, and
- (2) this device must accept any interference received, including interference that may cause undesired operation.

Note: This equipment has been tested and found to comply with the limits for a Class B digital device, pursuant to part 15 of the FCC Rules. These limits are designed to provide reasonable protection against harmful interference in a residential installation. This equipment generates, uses and can radiate radio frequency energy and, if not installed and used in accordance with the instructions, may cause harmful interference to radio communications. However, there is no guarantee that interference will not occur in a particular installation. If this equipment does cause harmful interference to radio or television reception, which can be determined by turning the equipment off and on, the user is encouraged to try to correct the interference by one or more of the following measures:

- Reorient or relocate the receiving antenna.
- Increase the separation between the equipment and receiver.
- Connect the equipment into an outlet on a circuit different from that to which the receiver is connected.
- Consult the dealer or an experienced radio/TV technician for help.

Note: The Grantee is not responsible for any changes or modifications not expressly approved by the party responsible for compliance. Such modifications could void the user's authority to operate the equipment. The device has been evaluated to meet general RF exposure requirements. This equipment complies with FCC's RF radiation exposure limits set forth for an uncontrolled environment. This device and its antenna(s) must not be co-located or in conjunction with any other antenna or transmitter.

Follow Us



Facebook



Instagram



YouTube



LinkedIn



YouTube



Website



www.pard.com

Business Cooperation



info@pard.com

Service Center



support@pard.com

PARD USA



Optimax Technology LLC

+1 (800) 986 4370

3500 Lakeside Court Suite 200, Reno, NV 89509, US



FC RoHS