

**PARD**



**USA**  
**User Manual**

**Night Vision Device**  
**NV007SP Series**



**LRF Version**



**Standard Version**

## Scan To Enjoy Privilege



**Scan The QR Code To Join Our Membership**

- 1 Extend warranty
- 2 Enjoy 1 on 1 expert service
- 3 Get the product experience officer opportunity

## CONTENTS

1. To Users .....	02
2. Precautions .....	02
3. Package Contents .....	03
4. Specifications .....	05
5. Description & Key Features .....	08
6. Components & Controls .....	09
7. Installation .....	10
8. Operation Instruction .....	14
8.1 Shortcut Mode .....	14
8.2 Menu Mode .....	17
9. Statement .....	23

## TO USERS

Thank you for your continued support and for choosing PARD NV007SP night vision device. Please read this manual carefully before using the device for the first time. Please follow the instructions in this manual to avoid any damage caused by improper use and to ensure that your device operates properly.











After reading, please keep this manual in a safe place, for future reference. This manual provides step-by-step instructions on how to use your night vision device and is intended for your reference only.

Some variations may inevitably occur due to upgrades in the firmware, we recommend you visiting PARD's official website for the most up-to-date information. PARD reserves the final right of interpretation of this manual.

## PRECAUTIONS

- Please remove the insulating tape before using the battery for the first time. It is recommended to use a fully charged lithium-ion battery with a rated voltage of 3.7V.
- When not in use, always turn off the device. If you are not going to use the device for more than 10 days, please remove the battery and store it in a safe place.
- Use extreme caution and care when using or transporting the device. It is recommended that original packaging be used during transportation.
- To avoid eye damage, avoid staring directly into the infrared fill light from a close distance!
- When this product's IR infrared light is turned on, it will use a large amount of energy. Aiming at flammable objects up close is absolutely prohibited because doing so could start a fire. Please go into sleep mode or turn off the IR infrared fill light when not in use.
- The device should be stored in a cool, dry, ventilated environment free of strong electromagnetic fields, with temperatures no lower than -13°F/-25°C and no higher than 104°F/40°C.
- Do not disassemble the device without authorization. If you encounter any problems, please contact our after-sales team and report them on our official website. Failure to do so will render the warranty service null and void.

## PACKAGE CONTENTS

Icon	Contents	Quantity
	Night vision device	1
	3.7V 18650 Rechargeable lithium-ion battery	1
	Velvet drawstring pouch	1
	Type-C cable	1
	Adapter	1
	Inserts	3
	Allen wrench	1
	Rubber O rings	2
	Insulating tape	1
	User's manual	1
	After sales card	1

**Accessories Instructions:**

1. Adapter: the adapter attaches to the rear of your day scope to convert your day scope into Night Vision. Two different diameters are available: 45/48 mm. The size you select is determined by the diameter of the scope you intend to mount the adapter on.
2. Inserts: Insert rings are available in different sizes, you can choose the appropriate thickness which can be used together with the adapter to fill the excess gap.
3. Allen wrench: the big one for installation and removal of adapter screws, the small one for red dot pointer adjustment.
4. Rubber O rings: can be set on the outer ring of the adaptor base to reduce the friction force generated during use.
5. Insulating tape: It can be wrapped around the day optic eyepiece to fill the gap and prevent wear and tear when using the adaptor.



## SPECIFICATIONS

Model	NV007SP/NV007SP-LRF
<b>Sensor</b>	
Resolution(px)	2560*1440
Sensitivity(Lux)	0.001
Frame rate(fps)	30
<b>Optics</b>	
Objective lens(mm)	22.5
Optical magnification(x)	4
Digital zoom(x)	1-3.5
Integral digital zoom (x)	4-14
Field of view horizontal	22°
Field of view vertical	12°
Field of view Diagonal	25°
Eye relief(mm)	25

Model		NV007SP/NV007SP-LRF
Diopter adjustment		±5D
Focus range		3cm-∞
Adaptor diameter(mm)		45/48 Optional
IR Illuminator		
IR type		VCSEL
IR power(w)		5
IR illuminating level		3 Levels
IR distance(m)		350m/383yds
IR wavelength(nm)		850/940 Optional
Display		
Type		OLED
Resolution(px)		1024*768
Color mode		Color/Black&white
Photo / Video		
Photo resolution(px)		2592*1944

<b>Model</b>		<b>NV007SP/NV007SP-LRF</b>
<b>Photo format</b>	JPG	
<b>Video resolution(px)</b>	1920*1080	
<b>Video format</b>	MP4	
<b>Storage</b>	TF card(128GB MAX)	
<b>Main Function</b>		
<b>LRF detection range (m/yds)</b>	1000/1200	
<b>Range unit selection</b>	meter/yard	
<b>Connections</b>		
<b>WiFi</b>	Yes	
<b>Supported Apps</b>	PardVision	
<b>Power Supply</b>		
<b>Battery type</b>	18650 Li-ion Battery	
<b>Rated voltage(V)</b>	3.7	
<b>Operating time(h, max)</b>	8	
<b>External power supply(V)</b>	USB Type-C	

Model		NV007SP/NV007SP-LRF
<b>Environmental Characteristic</b>		
Protective class	IP67	
Operating temp	-25°C ~40°C/-13 F~104 F	
Recoil resistance(J)	6000	
<b>Material</b>		
Housing	AL6061 & PLASTIC	
Objective lens	GLASS	
Product dimension (LxWxH, mm)	105*120*71/105*134*71	
N.W./pcs (with/without battery, g)	STD:335/290 ; LRF:355/310	

## DESCRIPTION & KEY FEATURES

The NV007SP is a back mounted digital night vision clip on and the latest addition to the NV007 series, featuring a high sensitivity 2K CMOS sensor and advanced technology. Convert your standard Day Scope into a high-performance night vision system quickly and easily. The NV007SP is designed for a variety of uses, including hunting and sport shooting.

### Key features

- 1 Quick attach and detach
- 2 Shorter body Length, compact design
- 3 Extremely sensitive 2560\*1440 CMOS sensor
- 4 1000m/1200yds Rangefinder
- 5 Direction adjustable IR light
- 6 Self-activated recording
- 7 Mute button
- 8 WiFi
- 9 Firmware upgrade
- 10 IP67 Waterproof
- 11 6000J Recoil resistance

COMPONENTS & CONTROLS

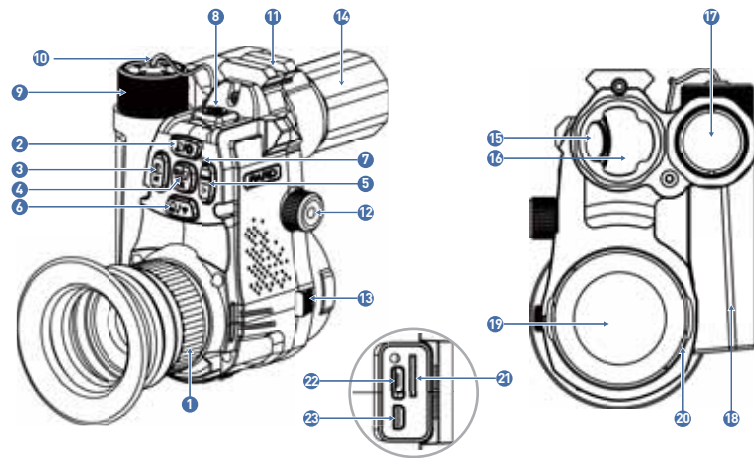

NO.	Name	No.	Name	No.	Name
①	Diopter focus	⑨	Battery cap	⑰	Direction adjustable IR light
②	Key 1	⑩	Battery cap leash	⑱	Battery compartment
③	Key 2	⑪	Picatinny rail	⑲	Objective lens
④	Key 3	⑫	Focus knob	⑳	Adapter base
⑤	Key 4	⑬	Mount release	㉑	TF card slot
⑥	Key 5	⑭	Rangefinder module	㉒	Type-C charging port
⑦	Power indicator	⑮	Range emitter	㉓	HDMI port
⑧	Power/Sleep	⑯	Range receiver		

## INSTALLATION

### 1.Unboxing

Before using this device, please do the following:

- ① Open the box and remove the device.
- ② Check to ensure that the package contents listed above are all included in the box.
- ③ Check the device for any damage to the display, body, lens, buttons, etc.
- ④ Make sure that the objective lens and eyepiece are clean & functioning properly.

**Note:** If any accessories are missing or damaged, please contact our after sales service at once.

## 2. Battery installation and startup

The battery installation steps are as follows:

2.1 Loosen the battery cap counterclockwise and remove the battery.



2.2 Remove the insulating tape.



2.3 Insert the battery, ensuring that the positive (+) side goes in first and tighten the battery cap clockwise.



2.4 To turn on the device, press and hold the power button for about 3 seconds. (When the power light illuminates and the PARD Logo appears on the screen, the device is ready for use.)

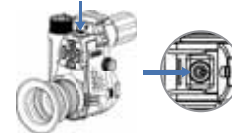

### Note:

- 1 Please use a single 18650 rechargeable lithium-ion battery rated 3.7V voltage.
- 2 Do not put battery into fire.
- 3 Do not put device into water when the battery cap is open.



- ④ Do not disassemble the device without authorization.
- ⑤ Do not pierce the device with sharp objects.
- ⑥ Battery should be kept out of reach of children, and the positive and negative terminals of the battery should be installed correctly.

### 3. Mount installation

The mount installation steps are as follows:

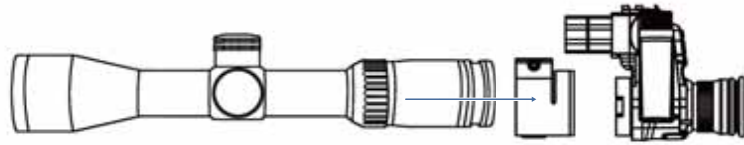

- ① Take out the night vision device, one adapter, inserts and an Allen wrench out of the box.
- ② Before installing the adaptor, turn on the device to see the clear icons on screen.
- ③ Wrap 1-2 layers of insulating tape on the eyepiece housing for protection.
- ④ Choose the correct size of the insert from the three sizes available and slip the insert on the day optical scope.
- ⑤ Attach the adapter by sliding it on top of the insert. Mount the clip-on to the adapter and when the screw is about to be tightened, calibrate the position of the reticle and keep the reticle centered.
- ⑥ After the reticle can be seen clearly in the center, tighten the screws on the adaptor, adjust the objective lens and to see the reticle clearly on the home screen.

**Note:** After finishing the installation, please adjust the optic scope to focus as the night vision clip-on only supports digital zoom.

#### 4. Diopter focusing

Diopter focusing is used to adjust users with different levels of corrected vision to clearly see the content displayed on the screen.

- 1 After powering the device, rotate the diopter focusing wheel so that you can see the screen clearly.
- 2 As long as you can clearly see the crosshair and text on the display, the diopter focusing setting has been completed.

**Note:** The image may not seem clear after diopter adjustment, as the objective lens still needs to be focused.



#### 5. Objective lens focusing

- 1 Before you focus the objective lens, ensure that the diopter focusing has been completed.
- 2 Aim at the target and adjust the objective focusing knob until you can see the crosshair in the optic scope clearly from the eyepiece.

**Operation Instruction :** //

**1. Shortcut Mode**

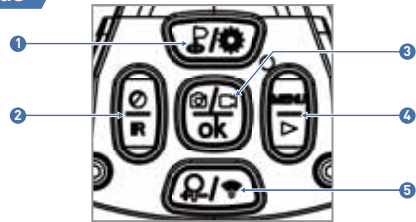

	Single press	Press and hold
Key1	LRF/up	turn on/off red dot pointer (red dot version)
Key2	IR light level adjustment	switch black & white/color mode
Key3	take a photo/OK	record video
Key4	menu/back	files/back
Key5	zoom/down	turn on/off WiFi

## Explanation

### Key 1

#### 1. Single press:

- ① **Home screen mode:** press [Key 1] to start the range detection function. The distance of target will be automatically detected and shown on the screen;
- ② **Menu mode:** press [Key 1] in the menu mode to scroll up and adjust the relevant option settings.

#### 2. Press and hold(only for red dot version) :

Home screen mode: press and hold [Key 1] to turn on/turn off the red dot pointer.

### Key 2

#### 1. Single press:

**Home screen mode:** press [Key 2] to turn on the first, second and third level of brightness of the IR light (you need to enter the black and white mode before you can perform this operation.)

#### 2. Press and hold:

**Home screen mode:** Home screen mode: press and hold [Key 2] to switch between black and white/color mode.

### Key 3

#### 1. Single press:

- ① **Home screen mode:** press [Key 3] to take a photo.
- ② **Menu mode:** press [Key 3] means confirm.

#### 2. Press and hold :

**Home screen mode:** press and hold [Key 3] to record a video. Press and hold [Key 3] again to save the video and exit.

#### Key 4

##### 1. Single press:

- ① **Home screen mode:** press [Key 4] to enter the menu interface.
- ② **Menu mode:** press [Key 4] to return to the home screen page.

##### 2. Press and hold :

**Home screen mode:** press and hold [Key 4] to enable the playback function. After entering this interface, the video and picture files stored on the memory card will be displayed.

- \* Press [Key 1]/[Key 5] to switch between files.
- Press [Key 3] to play/pause the saved videos.
- When playing videos, press [Key 1]/[Key 5] to fast forward or rewind 2x/4x/8x times.
- Press [Key 4] to access the following settings.

- |                  |                    |                 |
|------------------|--------------------|-----------------|
| 1)Delete:        | 2)File Protection: | 3)Slide Show:   |
| • Delete Current | • Lock Current     | • Two seconds   |
| • Delete All     | • Unlock Current   | • Five seconds  |
|                  | • Lock All         | • Eight seconds |
|                  | • Unlock All       |                 |

- Press and hold [Key 4] to return the home screen.

#### Key 5

##### 1. Single press:

- ① **Home screen mode:** press [Key 5] to switch the magnification.
- ② **Menu mode:** press [Key 5] to scroll down between menu options.

## 2. Press and hold:

**Home screen mode:** press and hold [Key 5] to turn on/off WiFi.

**Note:** When the WiFi is turned on, you cannot access the menu. Press and hold the [Key 5] to turn off WiFi and then enter the menu interface.

## 2. Menu Mode

Home screen mode: press [Key 4] to enter the full menu setting mode to set various function options. Press [Key 4] in the menu page to return to the home screen.

### 1. Reticle Center Position Adjustment :

When you enter the submenu, an auxiliary crosshair will appear on the screen to represent the center position of the image. Adjust the values of "X" and "Y" on the display screen to move the center position of the image, the crosshair of the day optical scope will be displayed at the center point of the screen.

- Press [Key 1]/[Key 5] to move the cursor to reticle center position adjustment, and press [Key 3] to enter the sub-menu.
- Press [Key 2]/[Key 4] to adjust the position of the "X" axis, and press [Key 1]/[Key 3] to adjust the position of the "Y" axis until the center of the auxiliary crosshair on the display screen aligns with the center point of the crosshair of the day optical scope.
- After confirming that the two crosshairs are aligned, press [Key 3] to save and return to the home screen, and the auxiliary crosshair will no longer be displayed on the screen.

### 2. Range Unit Selection :

Users can switch between "meter" or "yard" and the range unit can be updated instantly to meet the user's preference.

- Press [Key 1]/[Key 5] to move the cursor range unit selection option, and press [Key 3] to enter the sub-menu.

- Press [Key 2]/[Key 4] to choose between "meter" or "yard", then press [Key 3] to save and return to the previous page.

### 3. Self-activated Recording :

When the device detects recoil, the whole shooting process will be recorded in 20 second intervals. The incremental 20-second video footage will be saved on the TF card.

- Press [Key 1]/[Key 5] to move the cursor to the self-activated recording setting, and press [Key 3] to enter the sub-menu.
- Press the [Key 1]/[Key 5] to select "OFF", "ON" and "Impact Sensitivity" options.
- After selecting "Off" or "On", press [Key 3] to save and return to the previous page.
- After selecting "Impact Sensitivity", press [Key 3] to enter the sub-option menu of sensitivity level. Rotate the [knob] to select "Off", "Low", "Medium" or "High" mode. Press [Key 3] to save and return to the previous page.

### 4. Default Color :

There are 2 built-in color modes, "Color"/ "Black & White". Users can choose their preferred color settings.

- Press [Key 1]/[Key 5] to move the cursor to default color setting option, and press [Key 3] to enter the sub-menu.
- Press [Key 1]/[Key 5] to select "Color"/ "Black & White".
- Press [Key 3] to save and return to the previous page.

### 5. Brightness of IR :

Users can choose the level of brightness of IR settings.

- Press [Key 1]/[Key 5] to move the cursor to the brightness or IR setting option, and press [Key 3] to enter the sub-menu.
- Press [Key 1]/[Key 5] to select "Off", "1", "2", "3" and then press [Key 3] to save and return to the previous page.

### 6. Display Brightness :

Users can choose their preferred brightness settings.

- Press [Key 1]/[Key 5] to move the cursor to brightness setting option, and press [Key 3] to enter the sub-menu.

- Press [Key 1]/[Key 5] to select "Off" "Level 1" to "Level 6", and then press [Key 3] to save and return to the previous page.

#### **7. Auto Recording :**

After auto recording is on, device will start recording and continue to record after the next startup. To perform this function properly, please insert the memory card into the slot first.

- Press [Key 1]/[Key 5] to move the cursor to the auto recording setting option and press [Key 3] to enter the sub-menu.
- Press [Key 1]/[Key 5] to select "Off" or "On" options, press [Key 3] to save and return to the previous page.

#### **8. Loop Recording :**

Users can customize the segment recording duration. This can be set up under loop recording. When the capacity of the memory card is full, the new recording will automatically overwrite the previous saved files. When you select "Off" the recording will stop when the memory card is full, and the oldest video file will not be overwritten.

- Press [Key 1]/[Key 5] to move the cursor to the loop recording setting option, and press [Key 3] to enter the sub-menu.
- Press [Key 1]/[Key 5] to move the cursor to select preferred loop time duration "Off", "Three minutes", "Five minutes" or "Ten minutes". After selection, press [Key 3] to save and return to the previous page.

#### **9. Date Stamp :**

Users can set whether to display the time stamp in the lower right corner of photos and videos taken.

- Press [Key 1]/[Key 5] to move the cursor to the date stamp setting option, and press [Key 3] to enter the sub-menu.
- Press [Key 1]/[Key 5] to move the cursor to select "Off" or "On" options. After selection, press [Key 3] to save and return to the previous page.

#### **10. Record Audio :**

User can set whether to record audio synchronously in the video.

- Press [Key 1]/[Key 5] to move the cursor to the recording audio setting option, press [Key 3] to enter the sub-menu.
- Press the [Key 1]/[Key 5] to move the cursor to select "Off" or "On" option, after selection, press [Key 3] to save



and return to the previous page.

#### 11. Beep Sound :

Users can enable or disable the device key sound when an external HDMI display is connected.

- Press [Key 1]/[Key 5] to move the cursor to the beep sound setting option, press [Key 3] to enter the sub-menu.
- Press [Key 1]/[Key 5] to move the cursor to select "Off" or "On" option, after selection, press [Key 3] to save and return to the previous page.

#### 12. WiFi :

Through the WiFi connection, you can use the phone, PC or tablet as an external viewfinder enabling you to synchronously see the photos and videos on a larger screen and operate other remote settings.

- Press [Key 1]/[Key 5] to move the cursor to the WiFi setting option, and press [Key 3] to enter the sub-menu.
- Press [Key 1]/[Key 5] to move the cursor to select "On" or "Off" option. After selecting "Off" press [Key 3] to save and return to the previous page. Select "On" to enable WiFi and return to the home screen.

##### **Steps to connect to your mobile device:**

- Download "PardVision" from the Apple App Store or the Google Play Store.
- Turn on the WiFi on your device and on your mobile device.
- Search the WiFi on your mobile device (the device WiFi network is a string of characters starting with PARD, which is a unique string of numbers). Please enter the password: 12345678 to connect.
- Enter the application to operate and use.

**Note:** After the WiFi is turned on, you cannot access the menu. Press and hold [Key 5] to disable the WiFi and then enter the menu interface.

#### 13. Exposure :

Users can choose their preferred exposure settings.

- Press [Key 1]/[Key 5] to move the cursor to the exposure setting and press [Key 3] to enter the sub-menu.

- Press [Key 1]/[Key 5] to select your preferred option. Press [Key 3] to confirm your selection.

#### 14. Language :

Users can choose their preferred language.

- Press [Key 1]/[Key 5] to move the cursor to the language setting option, press [Key 3] to enter the sub-menu.
- Press [Key 1]/[Key 5] to move the cursor to select the desired language. After selecting, press [Key 3] to switch the system language and return to the previous page.

#### 15. Date/Time :

Users can set the system date and time of the device.

- Press [Key 1]/[Key 5] to move the cursor to the date/time setting option, press [Key 3] to enter the sub-menu.
- Press [Key 1]/[Key 5] to adjust the setting date and time value, press [Key 3] to switch options, press [Key 4] to save and return to the previous page.

#### 16. Format :

If users want to reformat the TF Card, it will delete all the data on the TF card permanently. Data cannot be recovered after reformatting. **Please operate with caution!**

- Press [Key 1]/[Key 5] to move the cursor to the format setting option, and press [Key 3] to enter the sub-menu.
- Press [Key 1]/[Key 5] to move the cursor to select "Cancel" or "OK" option. After selection, press [Key 3] to confirm the relevant operation and return to the previous page.

#### 17. Default Settings :

If users decide to reset the device, it will restore the device to the device's original operating system and delete all of the user data and all personalized settings in the device will be restored to the factory default settings. Please operate with caution!

- Press [Key 1]/[Key 5] to move the cursor to restore default setting option, press [Key 3] to enter the sub-menu.
- Press [Key 1]/[Key 5] to move the cursor to select "Cancel" or "OK" option. After selection, press [Key 3] to confirm the relevant operation and return to the previous page.

#### 18. Version :

This function displays the device's version.

- Press [Key 1]/[Key 5] to move the cursor to the version option, press [Key 3] to enter the sub-menu to view.
- Press [Key 3] again to exit and return to the previous page.

## Statement

### FCC WARNING

This device complies with part 15 of the FCC Rules. Operation is subject to the following two conditions:

- (1) This device may not cause harmful interference.
- (2) This device must accept any interference received, including interference that may cause undesired operation.

**Note:** This equipment has been tested and found to comply with the limits for a Class B digital device, pursuant to part 15 of the FCC Rules. These limits are designed to provide reasonable protection against harmful interference in a residential installation. This equipment generates, uses and can radiate radio frequency energy and, if not installed and used in accordance with the instructions, may cause harmful interference to radio communications. However, there is no guarantee that interference will not occur in a particular installation. If this equipment does cause harmful interference to radio or television reception, which can be determined by turning the equipment off and on, the user is encouraged to try to correct the interference by one or more of the following measures:

- Reorient or relocate the receiving antenna.
- Increase the separation between the equipment and receiver.
- Connect the equipment into an outlet on a circuit different from that to which the receiver is connected.
- Consult the dealer or an experienced radio/TV technician for help.

**Note:** The Grantee is not responsible for any changes or modifications not expressly approved by the party responsible for compliance. Such modifications could void the user's authority to operate the equipment. The device has been evaluated to meet general RF exposure requirements. This equipment complies with FCC's RF radiation exposure limits set forth for an uncontrolled environment. This device and its antenna(s) must not be co-located or in conjunction with any other antenna or transmitter.



## Follow Us

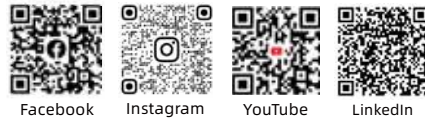

### Website

[www.pard.com](http://www.pard.com)

### Business Cooperation

[sales.support@optimaxtechnologyllc.com](mailto:sales.support@optimaxtechnologyllc.com)

### Service Center

[aftersales@optimaxtechnologyllc.com](mailto:aftersales@optimaxtechnologyllc.com)

### PARD USA

Optimax Technology LLC

+1 (800) 986 4370

3500 Lakeside Court Suite 200, Reno, NV 89509, US

